

Sofia

by Javier Pastor

lebom



Sofia

by Javier Pastor

lebom

CARACTERÍSTICAS TÉCNICAS

Estructura metálica

Varilla pintada al horno con pintura epoxilica de alta resistencia disponible en tres acabados: negro, blanco o arena

Sobre de mesa a elegir entre:

- Tapa de mármol disponible en cinco colores: italiano carrara, negro marquina, marrón imperial, verde guaco o marfil.
- Tablero lacado mate disponible en tres colores: blanco, negro o arena.

Revistero de cristal opcional

Disponible en tres colores: blanco, negro o arena.

Acabados

Estructura metálica



Blanco



Negro



Arena

Sobre de mesa tablero lacado



Blanco



Negro



Arena

Sobre de mesa mármol pulido o apomazado



Italiano carrara



Negro marquina

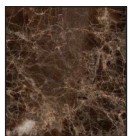

Marrón imperial

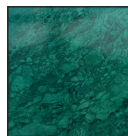

Verde guaco



Marfil

Revistero de cristal opcional



Blanco



Negro



Arena

Sofia

by Javier Pastor

lebom

MESAS

MESA 65x65

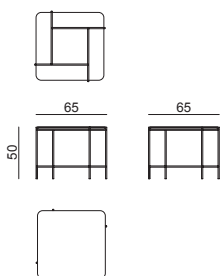

99944

MESA 130x65

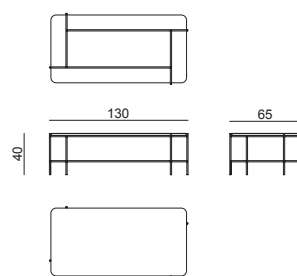

99945

MESA 100x100

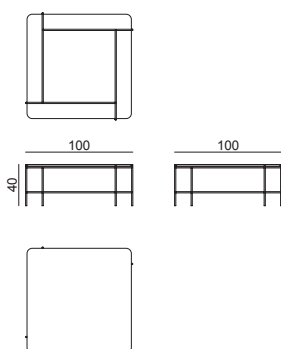

99946

MESA 120 CIRCULAR

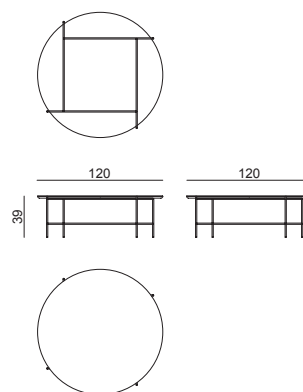

99947

MESA 60 CIRCULAR

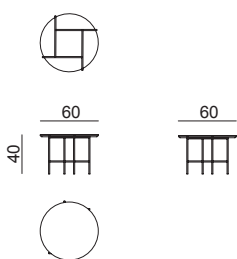

99948

MESA 80 CIRCULAR

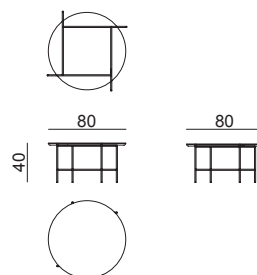

99949