

# Noah

by David Dolcini

**lebom**



# Noah

by David Dolcini

lebom

## CARACTERÍSTICAS TÉCNICAS

---

### Estructura metálica

Estructura metálica lacada al horno con pinturas epoxilicas de alta resistencia, acabadas en negro (RAL 9005).

### Sobre de mesa a elegir entre:

Tapa de mármol disponible en cinco colores: italiano carrara, negro marquina, marrón imperial, verde guaco o marfil.

### Revistero inferior

Revistero inferior acabado en roble bello.

### Acabados

Sobre de mesa mármol pulido o apomazado

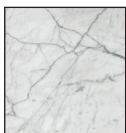

Italiano carrara

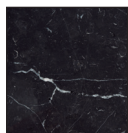

Negro marquina

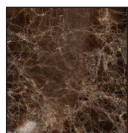

Marrón imperial

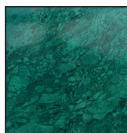

Verde guaco

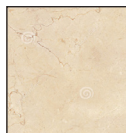

Marfil

### Revistero inferior de madera

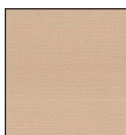

Roble bello

# Noah

by David Dolcini

lebom

## MESAS

---

MESA 60x60

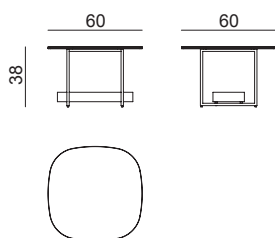

110090

MESA 60x100

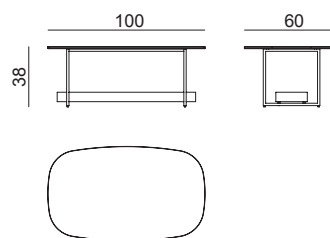

110091

MESA 100x100

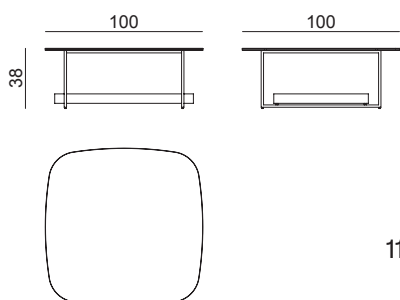

110092