

Large

by Ramón Esteve

lebom



Large

by Ramón Esteve

lebom

CARACTERÍSTICAS TÉCNICAS

Estructura

Madera maciza y tablero de DM.

Acolchado

Asiento de poliuretano de 40 kg Biogreen y recubierto de viscoelástico de 80 kg.
Respaldo de almohadones de algodón con relleno de micro fibra efecto pluma.

Tapizado

Cojines de asientos y respaldos desenfundables.

Cajón

Madera de Fresno (Chapado)

SOFÁS Y MÓDULOS

M.115 SB

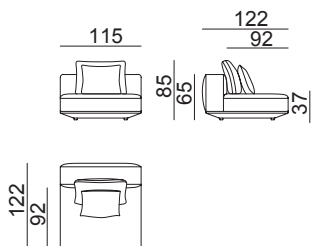

114221

M.180 CB BAJO

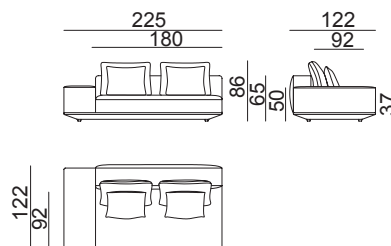

BD 114234
BI 114235

M.115 CB

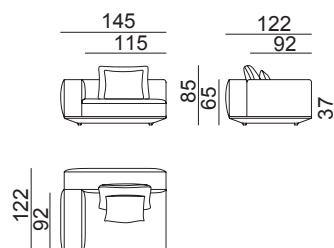

BD 114222
BI 114223

M.180 CAJÓN

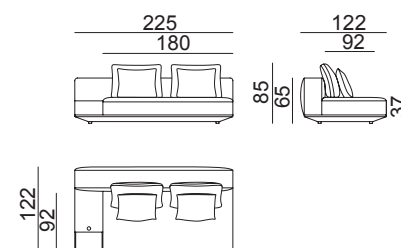

BD 114232
BI 114233

M.115 CBBAJO-SR

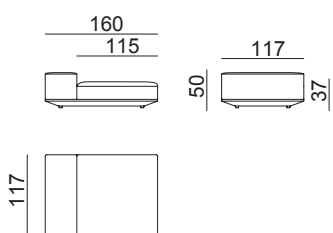

BD 114254
BI 114255

CHAISE LONGUE

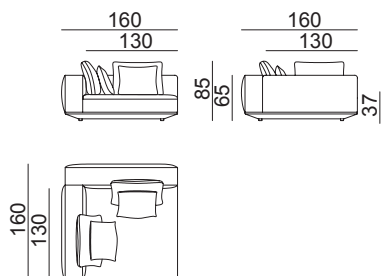

BD 114258
BI 114259

M.115 CBBAJO

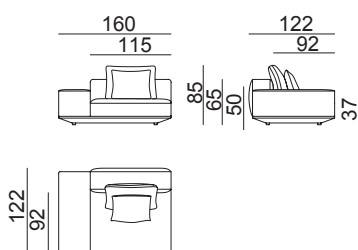

BD 114252
BI 114253

RINCÓN POLIGONAL

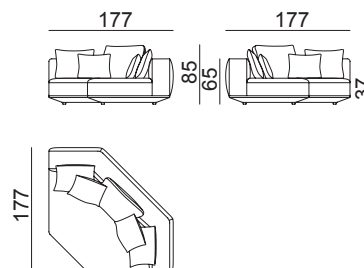

114271

SOFÁS Y MÓDULOS

RINCÓN

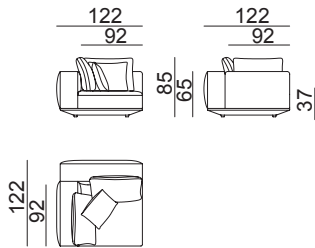

1142W 70

M.115 CB + M.115 SB + CHAISE LONGUE

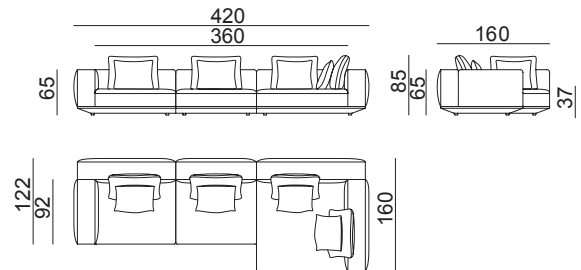

M.115 CB + M.115 CB

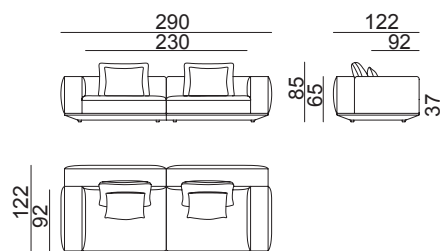

M.115 CBBAJO + M.115 SB + CHAISE LONGUE

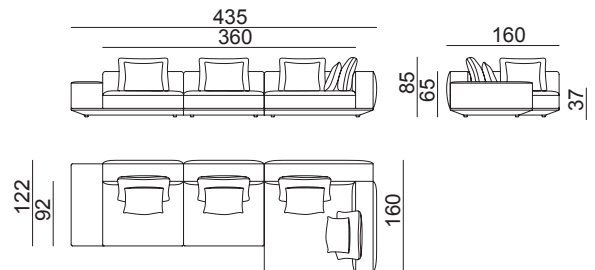

M.115 CBBAJO + M.115 CBBAJO

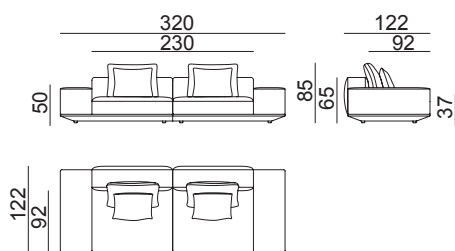

CHAISE LONGUE + M.180 CB BAJO

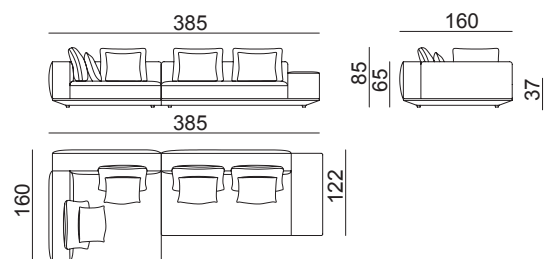

M.115 CB + M.115 SB + M.115 CB

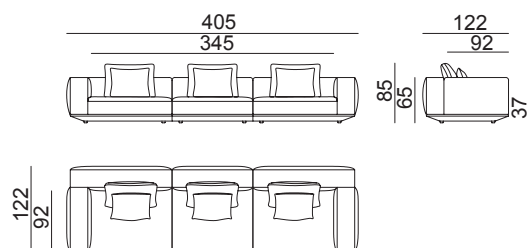

M.115 CBBAJO + M.115 SB + M.115 CBAJO

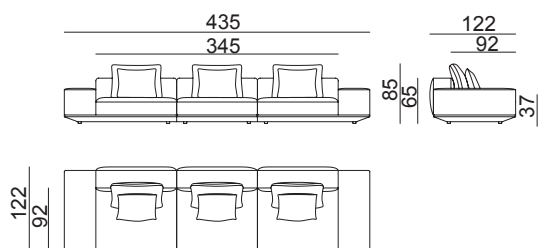

Large

by Ramón Esteve

lebom

SOFÁS Y MÓDULOS

CHAISE LONGUE + M.115 CBAJOSR + RINCÓN POLIGONAL + M.115 CBAJO

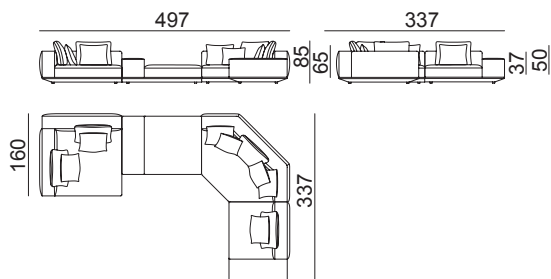

M.115 CB + M.115 SB + RINCÓN + M.115 CB

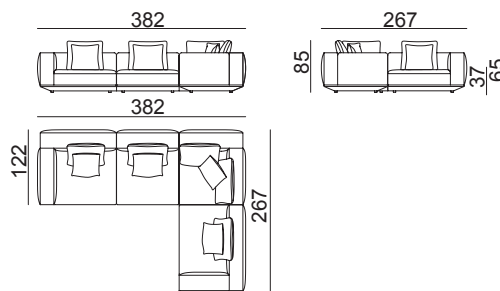

CHAISE LONGUE + M.180 CAJÓN + 115 CBAJOSR + RINCÓN POLIGONAL + M.115 CBAJO

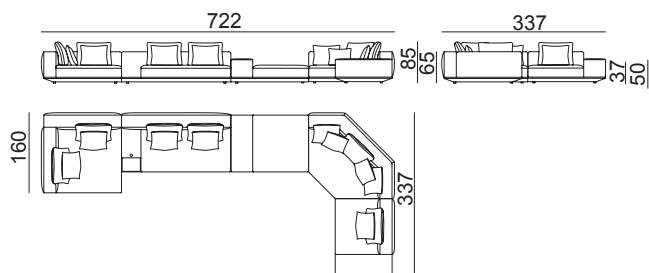

M.115 CB + M.115 SB + RINCÓN + M.115 SB + M.115 CB

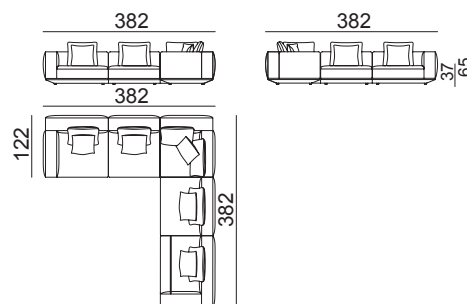

M.115 CB + M.115 SB + RINCÓN POLIGONAL + M.115 CB

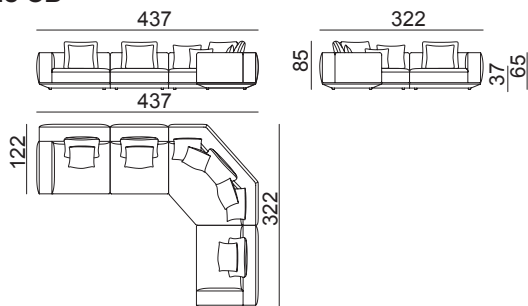

M. 100 SB

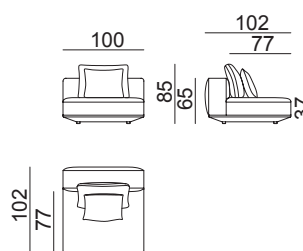

114441

M.115 CB + M.115 SB + RINCÓN POLIGONAL + M.115SB + M.115 CB

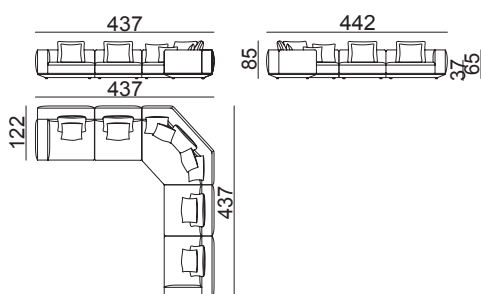

M.100 CB

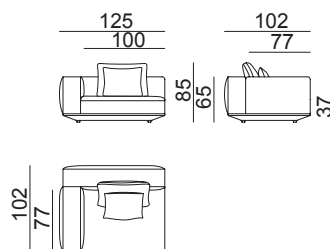

BD 114442
BI 114443

SOFÁS Y MÓDULOS

M.100 CBBAJO-SR

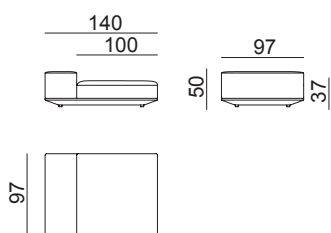

BD 114446
BI 114447

M.115 CBBAJO-SR

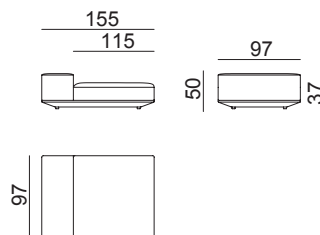

BD 114454
BI 114455

M.100 CBBAJO

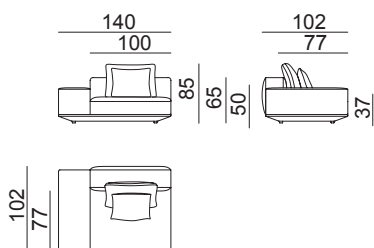

BD114444
BI 114445

M.115 CBBAJO

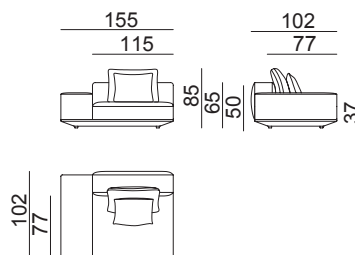

BD 114452
BI 114453

M.115 SB

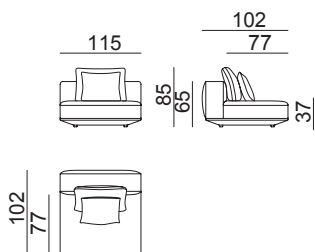

114421

M.180 CB BAJO

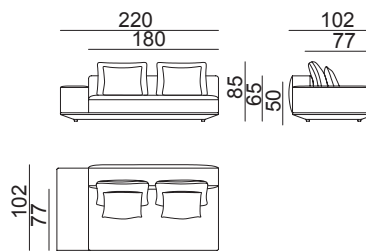

BD 114434
BI 114435

M.115 CB

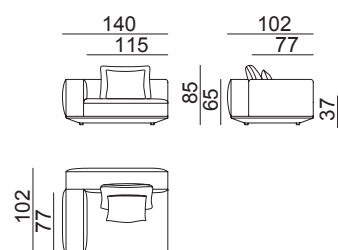

BD 114422
BI 114423

M.180 CAJÓN

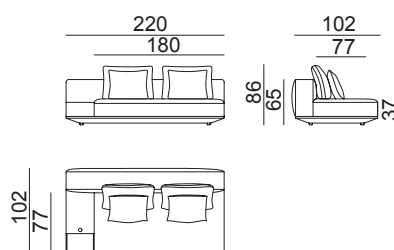

BD 114432
BI 114433

SOFÁS Y MÓDULOS

CHAISE LONGUE NORMAL 100

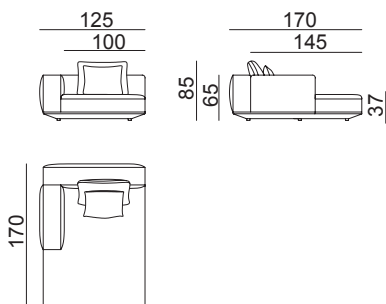

BD 114448
BI 114449

RINCÓN

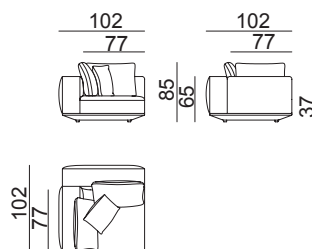

114470

CHAISE LONGUE NORMAL 115

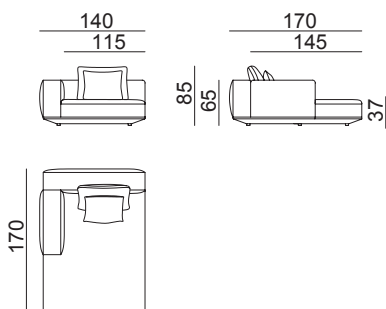

BD 114456
BI 114457

M.100 CB + M.100 CB

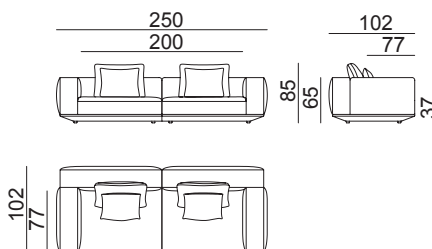

CHAISE LONGUE CUADRADA

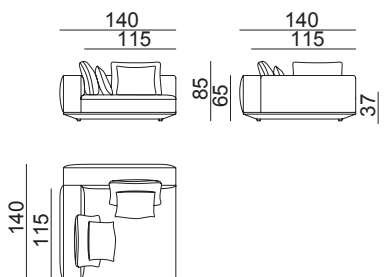

BD 114458
BI 114459

M.100 CBBAJO + M.100 CBBAJO

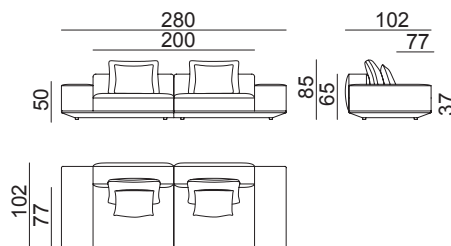

RINCÓN POLIGONAL

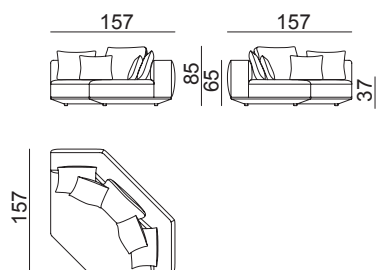

114471

M.115 CB + M.115 CB

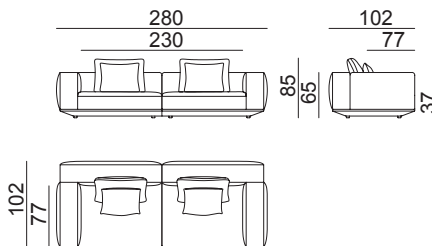

SOFÁS Y MÓDULOS

M.115 CBBAJO + M.115 CBBAJO

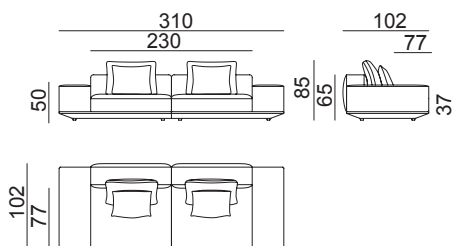

M.115 CB + M.115 SB + CHAISE LONGUE CUADRADA

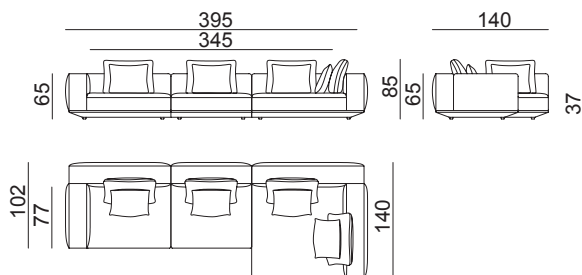

M.100 CB + M.100 SB + CHAISE LONGUE NORMAL 100

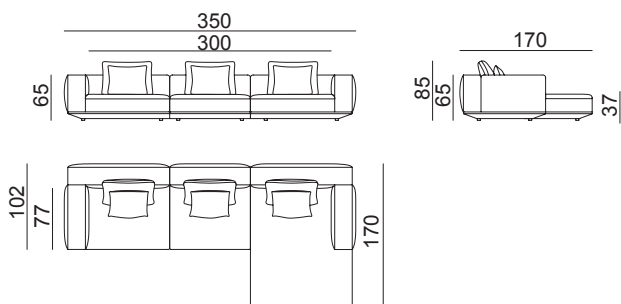

CHAISE LONGUE CUADRADA + M.180 CBBAJO

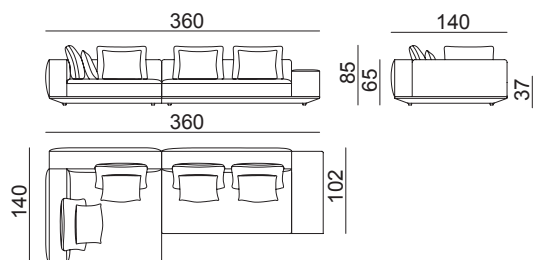

M.115 CB + M.115 SB + CHAISE LONGUE NORMAL 115

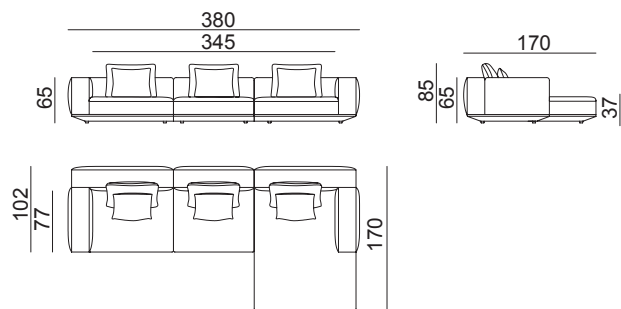

CHAISE LONGUE CUADRADA + M.100 CBBAJOSR + RINCÓN POLIGONAL + M.100 CBBAJO

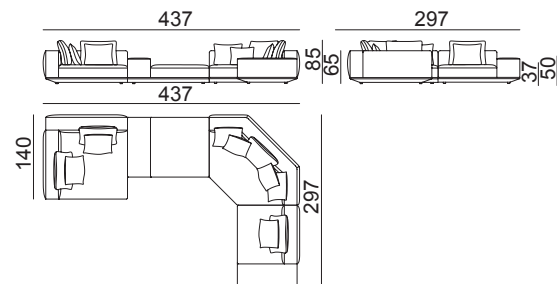

M.100 CB + M.100 SB + CHAISE LONGUE CUADRADA

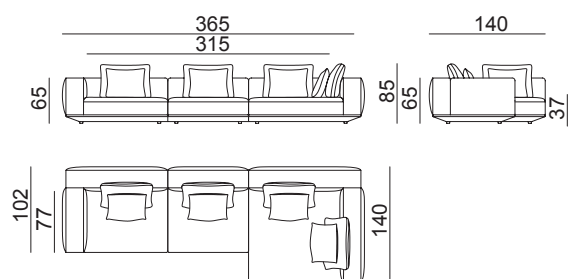

CHAISE LONGUE CUADRADA + M.180 CAJÓN + M.100 CBBAJOSR + RINCÓN POLIGONAL + M.100 CBBAJO

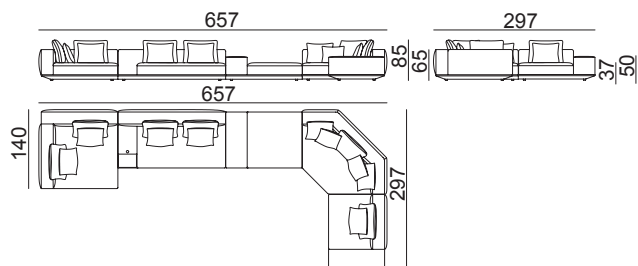

Large

by Ramón Esteve

lebom

SOFÁS Y MÓDULOS

CHAISE LONGUE CUADRADA + M.115 CBBAJOSR + RINCÓN POLIGONAL + M.115 CB BAJO

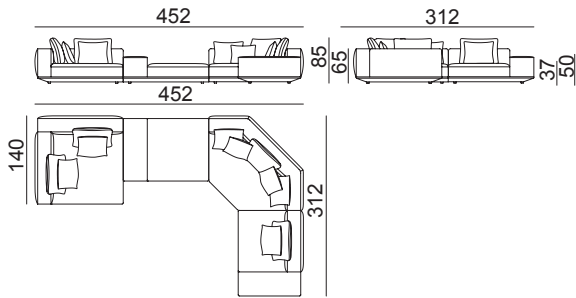

RINCÓN 327 (RINCÓN CUADRADO)

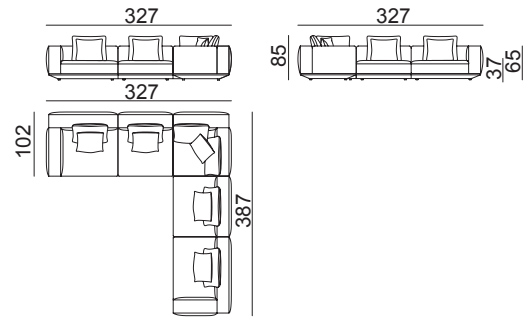

CHAISE LONGUE CUADRADA + M.180 CAJÓN + 115 CB BAJO SR + RINCÓN POLIGONAL + M.115 CB BAJO

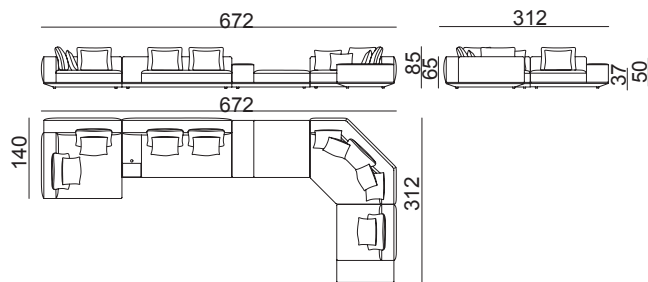

RINCÓN 357 (RINCÓN CUADRADO)

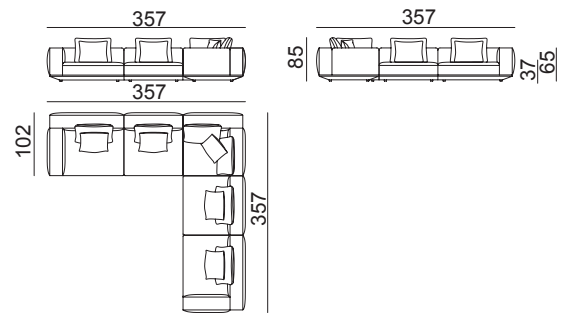

RINCONERA 357 (RINCÓN POLIGONAL)

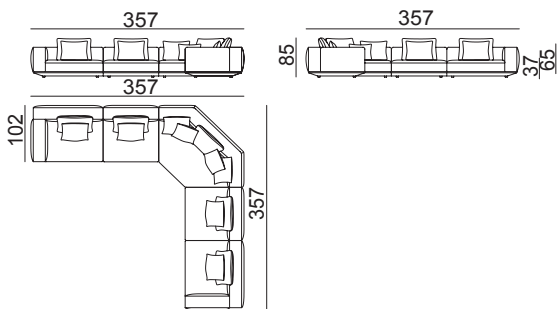

RINCONERA 382 (RINCÓN POLIGONAL)

